

# KOHLER engines

## OWNER'S MANUAL

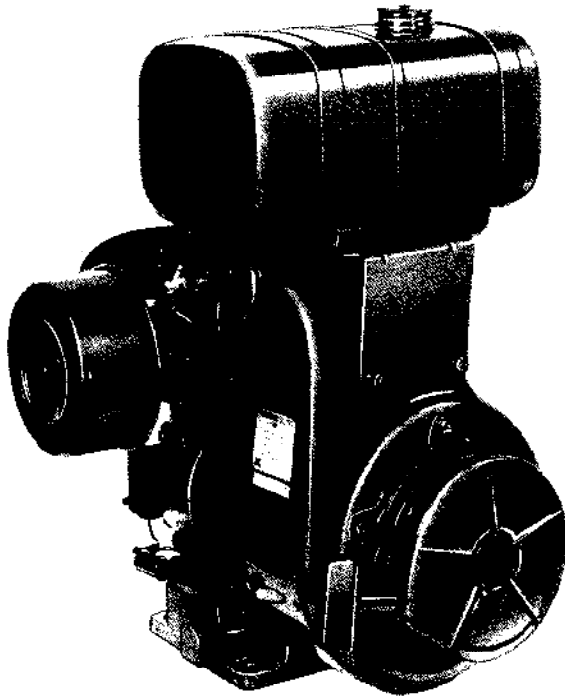

MODELS

K91,  
(4 hp)

K161, & K181  
(7 hp) (8 hp)

operating & maintenance  
instructions

**CONGRATULATIONS**—You have selected a fine four-cycle engine. Kohler designs long-life strength and on-the-job durability into each engine...making a Kohler engine dependable...dependability you can count on.



- Parts subject to the most wear and tear (like cylinders, crankshafts, and camshafts) are made from precision-formulated cast iron...and because the cast iron cylinders can be rebored, these engines can last even longer.
- Kohler engines are easy to service, all routine service parts—points, condenser, spark plug, air filter, carburetor—are easily and quickly accessible.
- Every Kohler engine is backed by a worldwide network of over 10,000 distributors and dealers. Service support is just a phone call away. Call 1-800-544-2444 (U.S. & Canada) for Sales & Service Assistance.

To keep your engine in top operating condition, follow the simple maintenance procedures given in this manual.

## Safety Information



### For Your Safety!

*These precautions should be followed at all times. Failure to follow these precautions could result in injury to yourself and others.*

 <b>WARNING</b>

<b>Explosive Fuel can cause fires and severe burns.</b>
Stop engine before filling fuel tank.

#### Explosive Fuel!



*Gasoline is extremely flammable and its vapors can explode if ignited. Store gasoline only in approved containers, in well ventilated, unoccupied buildings, away from sparks or flames. Do not fill the fuel tank while the engine is hot or running, since spilled fuel could ignite if it comes in contact with hot parts or sparks from ignition. Do not start the engine near spilled fuel. Never use gasoline as a cleaning agent.*

 <b>WARNING</b>

<b>Carbon Monoxide can cause severe nausea, fainting or death.</b>
Do not operate engine in closed or confined area.

#### Lethal Exhaust Gases!



*Engine exhaust gases contain poisonous carbon monoxide. Carbon monoxide is odorless, colorless, and can cause death if inhaled. Avoid inhaling exhaust fumes, and never run the engine in a closed building or confined area.*

<b>California Proposition 65 Warning</b>
<i>Engine exhaust from this product contains chemicals known to the State of California to cause cancer, birth defects, or other reproductive harm.</i>

 <b>WARNING</b>

<b>Rotating Parts can cause severe injury.</b>
Stay away while engine is in operation.

#### Rotating Parts!

*Keep hands, feet, hair, and clothing away from all moving parts to prevent injury. Never operate the engine with covers, shrouds, or guards removed.*

 <b>CAUTION</b>

<b>Electrical Shock can cause injury.</b>
Do not touch wires while engine is running.

#### Electrical Shock!

*Never touch electrical wires or components while the engine is running. They can be sources of electrical shock.*

 <b>WARNING</b>

<b>Accidental Starts can cause severe injury or death.</b>
Disconnect and ground spark plug lead before servicing.

#### Accidental Starts!



*Before servicing the engine or equipment, always disconnect the spark plug lead to prevent the engine from starting accidentally. Ground the lead to prevent sparks that could cause fires. Make sure the equipment is in neutral.*

 <b>WARNING</b>

<b>Hot Parts can cause severe burns.</b>
Do not touch engine while operating or just after stopping.

#### Hot Parts!

*Engine components can get extremely hot from operation. To prevent severe burns, do not touch these areas while the engine is running—or immediately after it is turned off. Never operate the engine with heat shields or guards removed.*

 <b>WARNING</b>

<b>Explosive Gas can cause fires and severe acid burns.</b>
Charge battery only in a well ventilated area. Keep sources of ignition away.

#### Explosive Gas!

*Batteries produce explosive hydrogen gas while being charged. To prevent a fire or explosion, charge batteries only in well ventilated areas. Keep sparks, open flames, and other sources of ignition away from the battery at all times. Keep batteries out of the reach of children. Remove all jewelry when servicing batteries.*

*Before disconnecting the negative (-) ground cable, make sure all switches are OFF. If ON, a spark will occur at the ground cable terminal which could cause an explosion if hydrogen gas or gasoline vapors are present.*

## FUEL RECOMMENDATIONS

### **⚠ WARNING: Explosive Fuel**

Gasoline is extremely flammable and its vapors can explode if ignited. Store gasoline only in approved containers, in well-ventilated, unoccupied buildings, away from sparks or flames. Do not fill the fuel tank while the engine is hot or running, since spilled fuel could ignite if it comes in contact with hot parts or sparks from ignition. Do not start the engine near spilled fuel; wipe up spills immediately. Never use gasoline as a cleaning agent.

### **General Recommendations**

Purchase gasoline in small quantities and store in clean, approved containers. A container with a capacity of 2 gallons or less with a pouring spout is recommended. Such a container is easier to handle and helps eliminate spillage during refueling. Do not use gasoline left over from the previous season, to minimize gum deposits in your fuel system and to insure easy starting. Do not add oil to the gasoline. Do not overfill the fuel tank. Leave room for the fuel to expand.

### **Fuel Type**

For best results, use only clean, fresh, unleaded gasoline with a pump sticker octane rating of 87 or higher. In countries using the Research method, it should be 90 octane minimum.

Unleaded gasoline is recommended as it leaves less combustion chamber deposits. Leaded gasoline may be used in areas where unleaded is not available and exhaust emissions are not regulated. Be aware however, that the cylinder head will require more frequent service. See "Required Maintenance" on page 7.

### **Gasoline/Alcohol blends**

Gasohol (up to 10% ethyl alcohol, 90% unleaded gasoline by volume) is approved as a fuel for Kohler engines. Other gasoline/alcohol blends are not approved.

### **Gasoline/Ether blends**

Methyl Tertiary Butyl Ether (MTBE) and unleaded gasoline blends (up to a maximum of 15% MTBE by volume) are approved as a fuel for Kohler engines. Other gasoline/ether blends are not approved.

## OIL RECOMMENDATIONS

Using the proper type and weight crankcase oil is extremely important as is checking oil daily and changing oil and filter regularly. (See "Required Maintenance" on page 7.) Failure to use the correct oil or using dirty oil causes premature engine wear and failure.

Before starting engine, fill the crankcase with the proper type and quantity of oil.

### **Oil Type**

Use high-quality detergent oil of API (American Petroleum Institute) service class SG or SH. Select the viscosity based on the air temperature at the time of operation as shown in the table.

### **Recommended SAE Viscosity Grades**

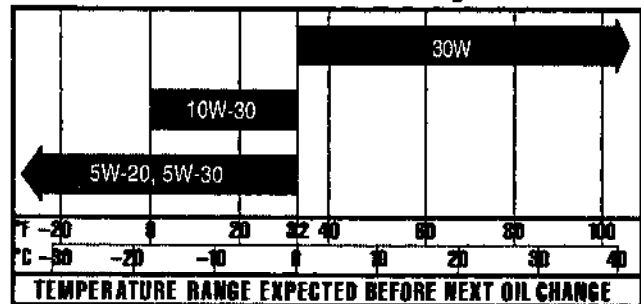

**Straight 30-weight oil is preferred.** SAE 10W-30 oil is not recommended above 32°F. Using this oil substantially increases oil consumption and combustion chamber deposits.

(See "Changing Oil" and "Required Maintenance" on pages 4 and 7.)

**NOTE:** Using other than service class SG or SH oil or extending oil change intervals longer than recommended could cause engine damage which is not covered by the engine warranty.

A logo or symbol on oil containers identifies the API service class and SAE viscosity grade.

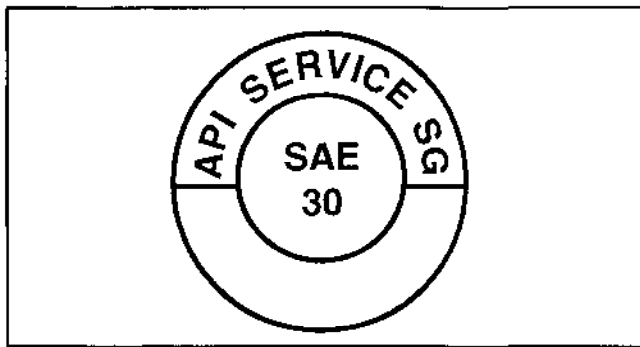

The top position of the symbol shows service class such as API SERVICE CLASS SG. The symbol may show additional categories such as SG/CC, CD. The center portion shows the viscosity grade such as SAE 30 in the example. If the bottom portion shows "Energy Conserving", it means that oil is intended to improve fuel economy in passenger car engines.

### Checking Oil

The importance of checking and changing crankcase oil cannot be overemphasized.

Check oil BEFORE EACH USE when the engine is cool and the oil has drained back into the sump. Add oil, if low, to bring level up to, but not over, the "F" mark on the dipstick.

Oil should always be checked while engine is *off* and on a level surface.

With threaded plug-type dipstick, remove and wipe oil off--reinsert, but do not turn plug in. To check oil level, *shoulder* plug on top of hole. After checking, again turn plug all the way into crankcase.

With extended oil fill tube and dipstick, push dipstick all the way down in tube then take reading.

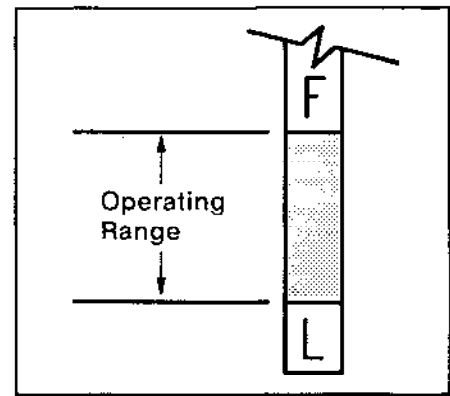

NOTE: To prevent extensive engine wear or damage, always maintain the proper oil level in the crankcase. Never operate the engine with the oil level below the "L" mark or over the "F" mark on the dipstick.

### Changing Oil

For a new engine, change oil after the first 5 hours of operation and then every 25 hours of operation thereafter.

Drain oil while engine is still warm from operation--it flows freely and carries away more impurities. (See Engine Identification illustration for location of drain plug.)

Remove the oil drain plug and oil fill cap. Tilt the engine slightly towards the oil drain to obtain better drainage.

After draining, reinstall drain plug. Make sure it is tightened securely. Fill with proper viscosity oil to "F" mark on dipstick. Always check level on dipstick before adding more oil.

Make sure the engine is level when filling and checking oil.

---

# OPERATING INSTRUCTIONS

---

ALSO READ THE OPERATING INSTRUCTIONS OF THE EQUIPMENT  
THIS ENGINE POWERS

---

---

## PRE-START CHECKLIST

---

- Check oil level. Add oil if low.
- Check fuel level. Add fuel if low.
- Check cooling air intake areas and external surfaces of engine. Make sure they are clean and unobstructed.
- Check that the air cleaner components and all shrouds, equipment covers, and guards are in place and securely fastened.
- Check that any clutches or transmissions are disengaged or placed in neutral. This is especially important on equipment with hydrostatic drive. The shift lever must be exactly in neutral to prevent resistance which could keep the engine from starting.



### **WARNING: Lethal Exhaust Gases!**

*Engine exhaust gases contain poisonous carbon monoxide. Carbon monoxide is odorless, colorless, and can cause death if inhaled. Avoid inhaling exhaust fumes, and never run the engine in a closed building or confined area.*

---

## STARTING

---

Move the throttle control lever to mid point of travel.

Move choke lever into full choke position and gradually return to **Off** position after engine starts and warms up.

**For Rope Start Engines**--Place the starting rope knot in the slot in starting pulley. Wrap the rope around the pulley. Pull the starter handle with a smooth, steady motion.

**For A Retractable Start Engine** - SLOWLY pull the starter handle until just past compression - STOP! Return starter handle, pull firmly with a smooth, steady motion to start. Pull the handle straight out to avoid excessive rope wear from the starter rope guide.

Extend the starting rope periodically and check its condition. If the rope is frayed, have it replaced immediately by your Kohler Engine Service Dealer.



### **WARNING: Accidental Starts!**

*Before extending and checking the retractable starter rope, remove the spark plug lead to prevent the engine from starting accidentally. Ground the lead to prevent sparks that could cause fires. Make sure the equipment is in neutral.*

**For An Electric Start Engine** -- Activate the starter switch. Release the switch as soon as the engine starts.

**NOTE:** Do not crank the engine continuously for more than 10 seconds at a time. If the engine does not start, allow a 60-second cool-down period between starting attempts. Failure to follow these guidelines can burn out the starter motor.

**NOTE:** If the engine develops sufficient speed to disengage the starter but does not keep running (a "false start"), the engine rotation must be allowed to come to a complete stop before attempting to restart the engine. If the starter is engaged while the flywheel is rotating, the starter pinion and flywheel ring gear may clash, resulting in damage to the starter.

If starter does not turn the engine over, shut off starter immediately. Do not make further attempts to start the engine until the condition is corrected. Do not jump start using another battery (refer to "BATTERY".) See your Kohler Engine Service Dealer for trouble analysis.

---

## BATTERY

---

A 12 volt battery is normally used. Refer to the operating instructions of the equipment this engine powers for specific information.

If the battery charge is not sufficient to turn over the engine, recharge the battery (see page 13).

---

## OPERATING

---

Optional spark arrestor mufflers are available from your Kohler Engine Service Dealer. Check your local laws and statutes regarding engine spark arrestor muffler requirements.

### Angle of Operation

These engines can be operated at angles up to 35° in any direction (intermittent operation when crankcase is filled to "F" mark on dipstick).

NOTE: Do not exceed these angles of operation as engine damage may result from lack of lubrication.

Refer to the operating instructions of the equipment this engine powers. It may have more stringent guidelines as to angle of operation due to equipment design.

### Cooling

NOTE: If debris builds up on air intake screen and other intake areas, STOP the engine immediately and clean. Obstructed air intake areas cause engine damage due to overheating.



### WARNING: Hot Parts!

*Engine components can get extremely hot from operation. To prevent severe burns, do not touch these areas while the engine is running - or immediately after it is turned off. Never operate the engine with heat shields or guards removed.*

### Engine Speed

NOTE: Do not tamper with the governor setting to increase the maximum speed. Overspeed is hazardous and will void the warranty.



### WARNING: Rope Starting Pulley Is Not a Drive Pulley!

*Do not use optional backup rope starting pulley as a drive pulley. Using starting pulley as a drive could loosen the flywheel fastener, resulting in bodily harm.*

---

## STOPPING

---

Disengage all possible load from the engine.

Place the throttle control in the idle position. Allow the engine to run at idle for 30-60 seconds.

Turn ignition switch OFF. On engines so equipped, press and hold STOP button until engine comes to a complete stop.

# MAINTENANCE INSTRUCTIONS

**⚠ WARNING: Accidental Starts!**

Before servicing the engine or equipment, always disconnect the spark plug lead to prevent the engine from starting accidentally. Ground the spark plug lead to prevent sparks that could cause fires. Make sure the equipment is in neutral.

These service procedures should also be performed as part of any seasonal tune-up.

Maintenance Required	Frequency
Clean Air Intake Screen <sup>1</sup> .....	DAILY
Check Oil Level .....	DAILY
Replenish Fuel Supply .....	DAILY
Service Precleaner .....	25 Hrs.
Change Oil .....	25 Hrs.
Check Reduction Gear Unit .....	50 Hrs.
Clean Cooling Fins and External Surfaces .....	50 Hrs.
Replace Air Cleaner Element <sup>1</sup> .....	100 Hrs.
Check Spark Plug Condition and Gap .....	100 Hrs.
Have Breaker Points Checked <sup>2</sup> .....	500 Hrs.
Have Ignition Timing Checked <sup>2</sup> .....	500 Hrs.
Have Valve and Tappet Clearance Checked <sup>2</sup> .....	500 Hrs.
Have Cylinder Heads Serviced <sup>2</sup> .....	500 Hrs. <sup>3</sup>
Have Starter Motor Drive Serviced <sup>2</sup> .....	500 Hrs.

<sup>1</sup>Perform these maintenance procedures more frequently under extremely dusty, dirty conditions.

<sup>2</sup>Have a Kohler Engine Service Dealer perform this service.

<sup>3</sup>250 hours when leaded gasoline is used.

## ENGINE IDENTIFICATION

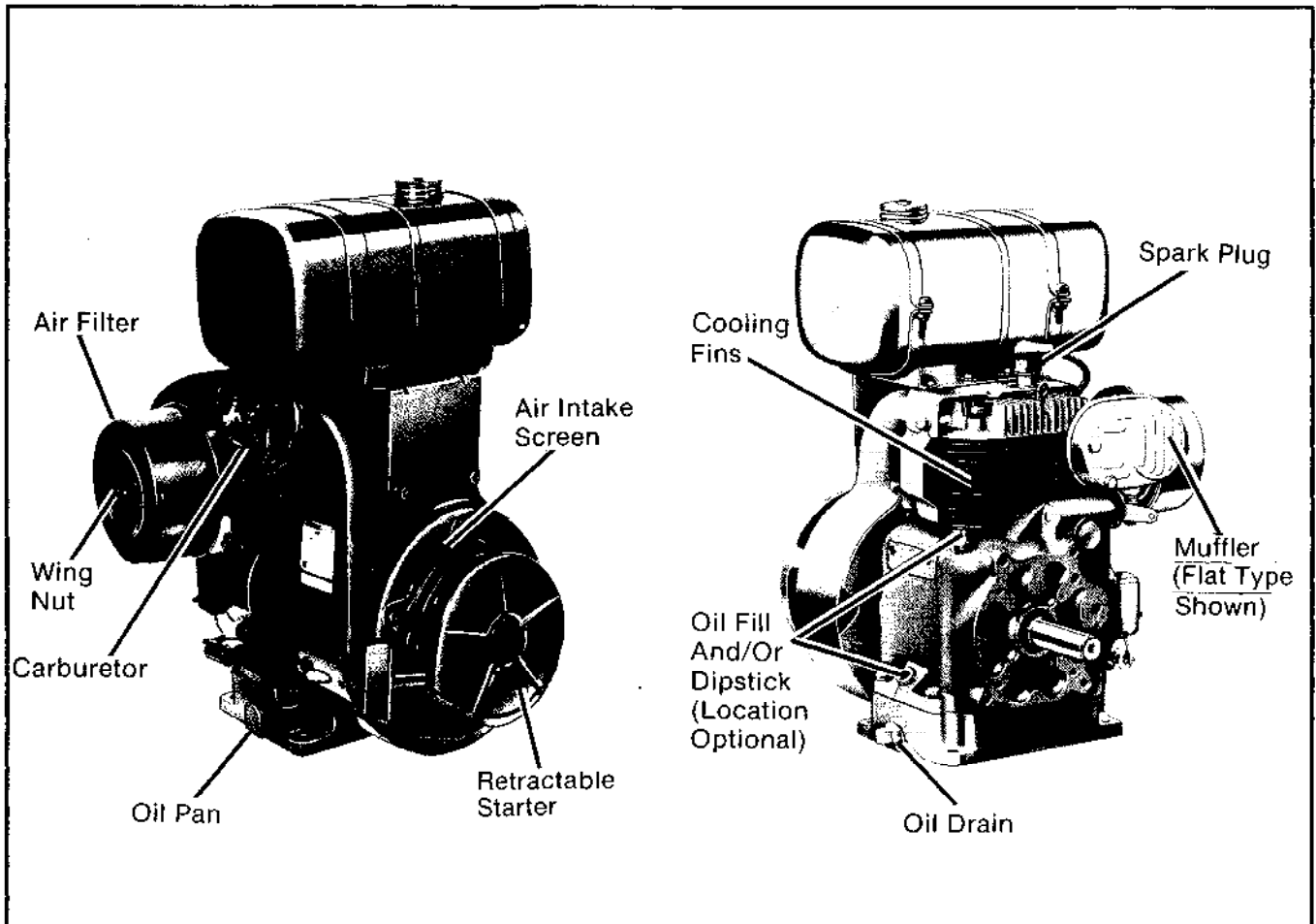

---

## COOLING SYSTEM

---

Every **50 hours** of operation (more often if conditions require) remove cooling shrouds and clean cooling fins. Also clean dust, dirt, and oil from external surfaces of engine, which can contribute to improper cooling. Make sure cooling shrouds are reinstalled. Operating engine without cooling shrouds will cause engine damage due to overheating.

---

## AIR CLEANER

---

This engine is equipped with a high density paper air cleaner element. Some specifications are also equipped with an optional oiled foam precleaner which surrounds the paper element.

**NOTE:** Operating the engine with damaged or loose components could allow unfiltered air into the engine causing premature wear and failure.

### Precleaner

If so equipped, wash and reoil the precleaner every **25 hours** of operation (more often under extremely dusty or dirty conditions).

1. Remove wing nut and air cleaner cover.
2. Remove precleaner from paper element.
3. Wash precleaner in warm water with detergent. Rinse thoroughly until all traces of detergent are eliminated. Squeeze out excess water (do not wring). Allow the precleaner to air dry.
4. Saturate precleaner with new engine oil and squeeze out excess oil.
5. Reinstall precleaner over paper element.
6. When precleaner replacement is necessary always use genuine Kohler parts.

### Paper Element

Every **100 hours** of operation (more often under extremely dusty or dirty conditions) replace the element.

1. Remove the precleaner (if so equipped) from paper element.
2. Do not wash the paper element or use **pressurized air** as this will damage the element. Replace a dirty, bent, or damaged element with a genuine Kohler element. Handle new elements carefully. Do not use if sealing surfaces are bent or damaged.
3. With air cleaner disassembled, check the base. Make sure it is secured and not bent or damaged. Also check the element cover, seals, and breather tube for damage or improper fit. Replace all damaged components.
4. Reinstall the paper element, precleaner, air cleaner cover and wing nut. Wing nut must be finger tightened 1/2 to 1 full turn after nut contact cover. Do not overtighten.
5. When air cleaner element replacement is necessary always use genuine Kohler parts.



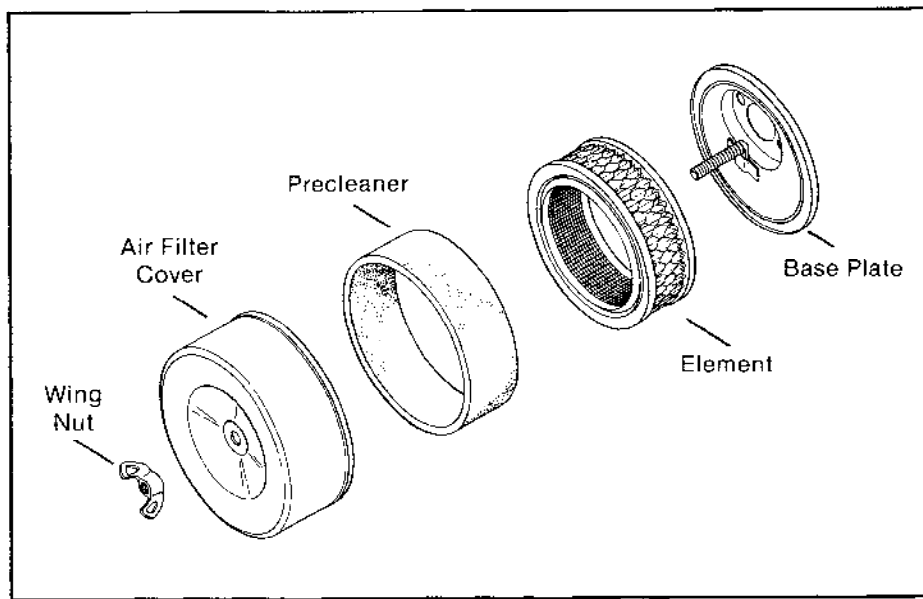

## SPARK PLUGS

Every **100 hours** of operation remove the spark plug, check condition and reset the gap, or replace with a new plug as necessary.

1. Before removing the spark plug, clean the area around the base of the plug to keep dirt and debris out of the engine.
2. Remove the plug and check its condition. Replace the plug if worn or reuse is questionable.

**NOTE:** Do not clean the spark plug in a machine using abrasive grit. Some grit could remain in the spark plug and enter the engine causing extensive wear and damage.

3. Check gap (0.025") using a wire feeler gauge. Adjust the gap as necessary by carefully bending the ground electrode. Install the plug and torque to 18-22 ft. lb.

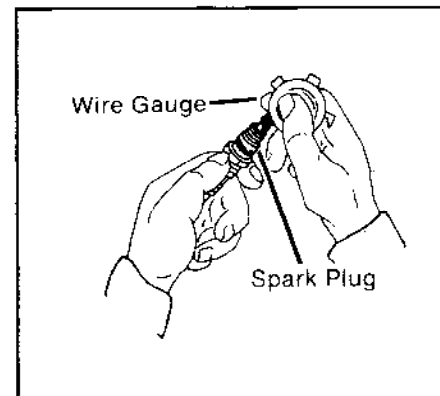

# CARBURETOR TROUBLESHOOTING AND ADJUSTMENTS

*Carburetor adjustments should be made only after engine has warmed up.*

Kohler K91, K161 and K181 engines are equipped with one of two basic types of carburetors - *Kohler* or *Walbro* - *fixed main jet* or *adjustable main jet*.

The carburetor is designed to deliver the correct fuel-to-air mixture to the engine under all operating conditions. The main fuel and idle fuel needles on adjustable jet carburetors are set at the factory and normally do not require further adjustment. On fixed jet carburetors, the low idle fuel needle is also set at the factory and normally does not need further adjustment. The main fuel jet is calibrated and installed at the factory and is not adjustable\*.

\*NOTE: Engines operating at altitudes above approximately 1830 m (6000 ft) may require a special "high altitude" main jet.

## TROUBLESHOOTING

If engine troubles are experienced that appear to be caused by the carburetor, check the following areas before adjusting the carburetor.

- Make sure the fuel tank is filled with clean, fresh gasoline.
- Make sure the fuel tank cap vent is not blocked and that it is operating properly.
- Make sure fuel is reaching the carburetor. This includes checking the fuel shut-off valve, fuel tank filter screen, in-line fuel filter, fuel lines, and fuel pump for restrictions or faulty components as necessary.
- Make sure the air cleaner base and carburetor is securely fastened to the engine using gaskets in good condition.
- Make sure the air cleaner element is clean and all air cleaner components are fastened securely.

If, after checking the items listed above, starting or engine operation problems exist, it may be necessary to adjust or service the carburetor.

NOTE: Carburetor adjustments should be made only after the engine has warmed up.

## Kohler Carburetor Adjustment

1. With the engine stopped, turn the fuel adjusting needles **in** (clockwise) until they bottom *lightly*.

NOTE: The tips of the fuel adjusting needles are tapered to critical dimensions. Damage to the needles and seats in carburetor body will result if the needles are forced.

2. **Preliminary Settings:** Turn the adjusting needles **out** (counterclockwise) from lightly bottomed as follows:

KOHLER ADJ.	LOW IDLE	MAIN FUEL
K91	1-1/2 TURNS	2 TURNS
K161	1-1/2 TURNS	3 TURNS
K181	1-1/4 TURNS	2 TURNS

3. Start the engine and run at half-throttle for 5 to 10 minutes to warm-up. The engine must be warm before making final settings (steps 4-6).
4. **Main Fuel Needle Setting:** This adjustment is required for adjustable main jet carburetors only. If the carburetor is a fixed main jet type refer to Walbro adjustment.

Place the throttle into the "fast" position. If possible, place the engine under load.

Turn the main fuel adjusting needle **out** (counterclockwise) from the preliminary setting until the engine speed decreases (rich). Note the position of the needle.

Now turn the adjusting needle **in** (clockwise). The engine speed may increase, then it will decrease as the needle is turned in (lean). Note the position of the needle.

Set the adjusting needle **midway** between the rich and lean settings.

5. **Low Idle Fuel Needle Setting:** Place the throttle into the "idle" or "slow" position.

Turn the low idle fuel adjusting needle **out** (counterclockwise) from the preliminary setting until the engine speed decreases (rich). Note the position of the needle.

Now turn the adjusting needle **in** (clockwise). The engine speed may increase, then it will decrease as the needle is turned in (lean). Note the position of the needle.

Set the adjusting needle **midway** between the rich and lean settings.

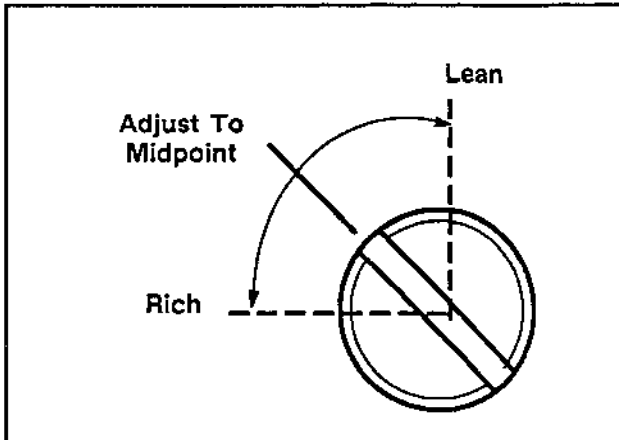

6. **Low Idle Speed Setting:** Place the throttle control into the idle or slow position. Set the idle speed to 1200\* RPM ( $\pm 75$  RPM) by turning the idle speed adjusting screw in or out. Check the speed using a tachometer.

**NOTE:** \*The actual idle speed depends on the application. Refer to the equipment manufacturer's instructions for specific low idle speed settings. The recommended low idle speed for the Basic Engines is 1200 RPM. To ensure best results when setting the low idle fuel needle, the low idle speed must not exceed 1500 RPM.

## Walbro Carburetor Adjustment

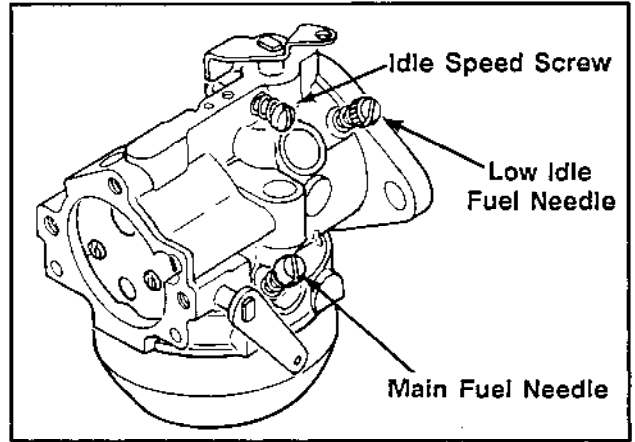

In general, turning the adjusting needles **in** (clockwise) decreases the supply of fuel to the carburetor. This gives a *leaner* fuel-to-air mixture. Turning the adjusting needles **out** (counterclockwise) increases the supply of fuel to the carburetor.

1. With the engine stopped, turn the adjusting needle(s) **in** (clockwise) until it bottoms *lightly*.

**NOTE:** The tips of the fuel adjusting needles are tapered to critical dimensions. Damage to the needles and the seats in carburetor body will result if the needles are forced.

2. **Preliminary Settings:** Turn the adjusting needle(s) **out** (counterclockwise) from lightly bottomed as follows or to the rich side of adjustment.

WALBRO FIXED JET	LOW IDLE
K91	NOT APPL.
K161	NOT APPL.
K181	2-1/2 TURNS

WALBRO ADJ	LOW IDLE	MAIN FUEL
K91	1-3/4 TURNS	3/4 TURNS
K161	2-1/4 TURNS	1-1/8 TURNS
K181	2-1/2 TURNS	3/4 TURNS

3. Start the engine and run at half throttle for five to ten minutes to warm up. The engine must be warm before making final settings.
4. **Main Fuel Needle Setting:** *This adjustment is required only for adjustable main jet carburetors. If the carburetor is a fixed main jet type, disregard this setting.*

Place the throttle into the "fast" position.

Turn the adjusting needle **In** (clockwise). The engine speed may increase, then it will decrease as the needle is turned in (lean). Note the position of the needle. Back the needle out approximately 1/8 to 1/4 turn. See figure below for best main fuel performance.

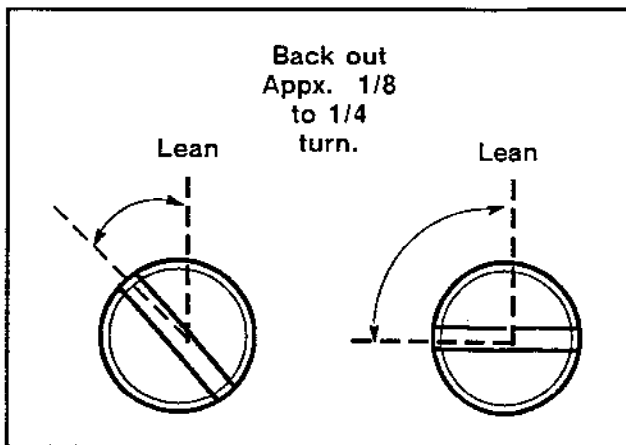

**Optimum Main Fuel Setting.**

5. **Low Idle Fuel Needle Setting:** Place the throttle into the "idle" or "slow" position.

Turn the adjusting needle **In** (clockwise). The engine speed may increase, then it will decrease as the needle is turned in (lean). Note the position of the needle.

Back the needle out approximately 1/8 to 1/4 turn. See figure below for best low idle fuel performance.

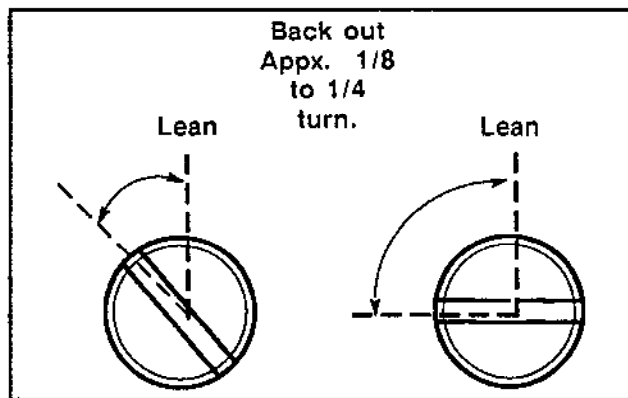

**Optimum Low Idle Fuel Setting.**

6. **Low Idle Speed Setting:** Place the throttle control into the "idle" or "slow" position. Set the low idle speed to **1200 RPM\*** (+ or - 75 RPM) by turning the low idle speed adjusting screw **In** or **Out**. Check the speed using a tachometer.

**\*NOTE:** The actual low idle speed depends on the application. Refer to the equipment manufacturer's instructions for specific low idle speed settings. To ensure best results when setting the low idle fuel needle, the low idle speed must not exceed 1500 RPM.

---

## FUEL FILTER

---

Some engines are equipped with an in-line fuel filter. Visually inspect the filter periodically and replace when dirty with a genuine Kohler filter.

TROUBLESHOOTING	Problem	No Fuel	Improper Fuel	Dirt In Fuel Line	Dirty Air Screen	Incorrect Oil Level	Engine Over-Loaded	Dirty Filter Element	Faulty Spark Plug
When a problem occurs, do not overlook the simple causes. For example, starting problems could be caused by an empty fuel tank. The table lists some common causes of troubles.	Will not start	X	X	X			X	X	X
	Hard starting	X	X	X			X	X	X
Do not attempt to service or replace major items or any items that call for special timing or adjustment procedures (governor, valves, etc.). Have this work done by your Kohler Engine Service Dealer.	Stops suddenly	X		X	X	X	X	X	
	Lacks power		X	X	X	X	X	X	X
	Operates erratically		X	X	X		X	X	X
	Knocks or pings		X		X		X		X
	Skips or misfires		X	X	X			X	X
	Backfires		X	X			X	X	X
	Overheats		X			X	X	X	X
	High fuel consumption		X				X	X	X

## BATTERY CHARGING



### **WARNING: Explosive Gas!**

Batteries produce explosive hydrogen gas while being charged. To prevent a fire or explosion, charge batteries only in well ventilated areas. Keep sparks, open flames, and other sources of ignition away from the battery at all times. Keep batteries out of the reach of children. Remove all jewelry when servicing batteries.

Before disconnecting the negative (-) ground cable, make sure all switches are OFF. If ON, a spark will occur at the ground cable terminal which could cause an explosion if hydrogen gas or gasoline vapors are present.

## REDUCTION GEAR UNITS

On engines equipped with a reduction gear unit, remove the oil plug on lower part of cover every 50 hours to check oil level. With the engine level, the oil level of the unit should be up to the bottom of the oil plug hole. To add oil, remove the vented plug at the top of the unit. Use the same weight and grade of oil as used in the engine crankcase.

---

## MODEL DESIGNATION

---

The Model number designates the cubic inch displacement and the number of cylinders--Model K181S; for example: designates 18 cubic inch displacement, 1 designates single cylinder. The letter suffix designates a specific version as follows:

Suffix	Designation
EP	Generator Set
P	Pump Model
R	Gear Reduction
S	Electric Start
T	Retractable Start

---

## ENGINE IDENTIFICATION NUMBERS

---

When ordering parts, or in any communication involving an engine, always give the **Model, Specification, and Serial Numbers** of the engine.

The engine identification numbers appear on decal (or decals) affixed to the engine shrouding. See figure below. Include letter suffixes, if there are any.

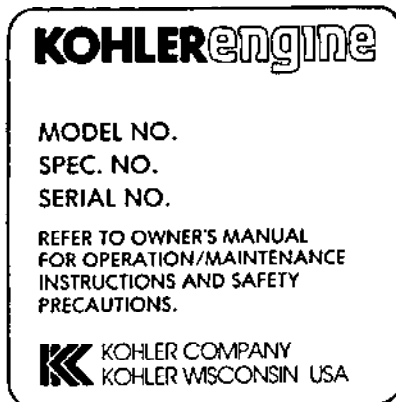

Record your engine identification numbers on the identification plate illustration for future reference.

---

## PARTS ORDERING

---

The engine Specification, Model, and Serial numbers are required when ordering replacement parts from your Kohler Engine Service Dealer. These numbers are found on the identification plate which is affixed to the engine shrouding. Include letter suffixes if there are any. See "Engine Identification Numbers" above.

*Always insist on genuine Kohler parts. All genuine Kohler parts meet strict standards for fit, reliability, and performance.*

---

## STORAGE

---

If the engine is to be out of service for approximately two months or more, use the following storage procedure:

1. Clean exterior surfaces of the engine.
2. Change oil when engine is still warm from operation. See "Changing Oil" on page 4.
3. Drain reduction gear unit, if so equipped, and refill with same oil as used in engine for season of operation.
4. The fuel system must be completely emptied, or the gasoline must be treated with a stabilizer to prevent deterioration. If you choose to use a stabilizer, follow the manufacturers recommendations, and add the correct amount for the capacity of the fuel system. Fill the fuel tank with clean, fresh gasoline. Run the engine for 2-3 minutes to get stabilized fuel into the carburetor.  
  
To empty the system, run the engine until the tank and system are empty.
5. Remove the spark plug. Add one tablespoon of engine oil into each spark plug hole. Install plugs but do not connect plug leads. Crank the engine two or three revolutions.
6. Remove plug, cover hole with thumb and turn engine over until piston is at top of stroke--determined when pressure against thumb is greatest.
7. Store the engine in a clean dry place.

---

## MAJOR REPAIR

---

Major repair information is provided in the Kohler Single Cylinder Service Manual, available from your Kohler Engine Service Dealer. However, major repair generally requires the attention of a trained mechanic and the use of special tools and equipment. Your Kohler Engine Service Dealer has the facilities, training, and genuine replacement parts necessary to properly perform the service. For sales and service assistance call 1-800-544-2444 (U.S. and Canada) or contact your Kohler Engine Dealer or Service Distributor. They're in the Yellow Pages under ENGINES, GASOLINE.

## SPECIFICATIONS

### K91

Power Rating at 4000 RPM	4 hp (3 kW)
Displacement	8.9 in <sup>3</sup> (145 cm <sup>3</sup> )
Bore	2.375 in (60.33 mm)
Stroke	2.000 in (50.80 mm)
Approx. Weight	43 lb (19.5 kg)
Oil Capacity	1.5 U.S. pints (0.7 L)
Spark Plug Gap	0.025 in* (0.65 mm)
Spark Plug Size	14 mm
Spark Plug Type	Champion RJ8C or equivalent
Breaker Point Gap (Nominal)	0.020 in (0.50 mm)

### K161

Power Rating at 3600 RPM	7 hp (5.2 kW)
Displacement	16.9 in <sup>3</sup> (277 cm <sup>3</sup> )
Bore	2.938 in (74.62 mm)
Stroke	2.500 in (63.50 mm)
Approx. Weight	65 lb (29.5 kg)
Oil Capacity	2.5 U.S. pints (1.2 L)
Spark Plug Gap	0.025 in* (0.65 mm)
Spark Plug Size	14 mm
Spark Plug Type	Champion RJ8C or equivalent
Breaker Point Gap (Nominal)	0.020 in (0.50 mm)

### K181

Power Rating at 3600 RPM	8 hp (6 kW)
Displacement	18.6 in <sup>3</sup> (305 cm <sup>3</sup> )
Bore	2.938 in (74.62 mm)
Stroke	2.750 in (69.85 mm)
Approx. Weight	65 lb (29.5 kg)
Oil Capacity	2.5 U.S. pints (1.2 L)
Spark Plug Gap	0.025 in* (0.65 mm)
Spark Plug Size	14 mm
Spark Plug Type	Champion RJ8C or equivalent
Breaker Point Gap (Nominal)	0.020 in (0.50 mm)

\*Gaseous fueled engines-gap .018 in (0.45 mm).

## LIMITED 1 YEAR ENGINE WARRANTY

We warrant to the original consumer that each new engine sold by us will be free from manufacturing defects in materials or workmanship in normal service for a period of one (1) year from date of purchase, provided it is operated and maintained in accordance with Kohler Co.'s instructions and manuals.

Our obligation under this warranty is expressly limited, at our option, to the replacement or repair at Kohler Co., Kohler, Wisconsin, 53044, or at a service facility designated by us, of such part or parts as inspection shall disclose to have been defective.

### EXCLUSIONS:

This warranty does not apply to defects caused by casualty or unreasonable use, including faulty repairs by others and failure to provide reasonable and necessary maintenance.

The following items are not covered by this warranty:

Engine accessories, such as fuel tanks, clutches, transmissions, power drive assemblies, and batteries, unless supplied or installed by Kohler Co. These are subject to the warranties, if any, of their manufacturers.

WE SHALL NOT BE LIABLE FOR SPECIAL, INDIRECT, INCIDENTAL, OR CONSEQUENTIAL DAMAGES OF ANY KIND, including but not limited to labor costs or transportation charges in connection with the replacement or repair of defective parts.

ANY IMPLIED OR STATUTORY WARRANTIES, INCLUDING WARRANTY OF MERCHANTABILITY OR FITNESS FOR A PARTICULAR PURPOSE, ARE EXPRESSLY LIMITED TO THE DURATION OF THIS WRITTEN WARRANTY. We make no other express warranty, nor is anyone authorized to make any in our behalf.

Some states do not allow limitations on how long an implied warranty lasts, or the exclusion or limitation of incidental or consequential damages, so the above limitation or exclusion may not apply to you.

This warranty gives you specific legal rights, and you may also have other rights which vary from state to state.

### TO OBTAIN WARRANTY SERVICE:

Purchaser must bring the engine to an authorized Kohler service facility. For the facility nearest you, consult your Yellow Pages or write Kohler Co., Attn: Engine Warranty Service Dept., Kohler, Wisconsin 53044.

ENGINE DIVISION, KOHLER CO., KOHLER, WISCONSIN 53044

ENGINE DIVISION, KOHLER CO., KOHLER, WISCONSIN 53044

FOR SALES AND SERVICE INFORMATION  
IN U.S. AND CANADA, CALL  
1-800-544-2444

FORM NO.:	ENS-593-F
ISSUED:	3/84
REVISED:	7/97
MAILED:	

LITHO IN U.S.A.